

SPIKA MS 1000 REMOTE

MODULAR ICE CUBE MACHINE

208 - 230 V / 60 Hz

FEATURES

- ▶ PRODUCES FULL DICE OR HALF DICE ICE CUBES
- ▶ HIGH EFFICIENCY EVAPORATOR
- ▶ SMART WATER DISTRIBUTOR THAT IMPROVES DROP-OFF EFFICIENCY
- ▶ EASY ACCESS FOR SERVICE BY REMOVING THE PANELS WITH A SINGLE SCREWDRIVER
- ▶ SMART ELECTRONIC BOARD CONTROLS EVERY PARAMETER IN THE MACHINE AND SHOWS THE DIAGNOSIS OF POSSIBLE INCIDENCES
- ▶ HIGH RESISTANCE EXTERNAL FRAME IN AISI 304 STAINLESS STEEL



	 24 H	 70°F/21°C 50°F/10°C lbs (Kg)	 90°F/32°C 70°F/21°C lbs (Kg)	 in (mm)	 in (mm)
SPIKA MS 1000 R		1041 (472)	1006 (456)	Width 30" (762) Depth 24" (620) Height 30" (762)	Width 34.41" (874) Depth 25" (635) Height 32.92" (836)
RC10	-	-	-	Width 29.37" (762) Depth 16.81" (427) Height 22.29" (566)	Width 30.32" (770) Depth 20.08" (510) Height 27.56" (700)

SPIKA HALF DICE
 0.9" (W) x 0.4" (D) x 1" (H)
 23 mm (W) x 11 mm (D) x 26 mm (H)
 Average dimensions

SPIKA FULL DICE
 1" (W) x 0.9" (D) x 1" (H)
 26 mm (W) x 23 mm (D) x 26 mm (H)
 Average dimensions

ACCESSORIES

INCLUDED	NOT INCLUDED
 SCOOP	 DOUBLE 11" FILTER ANTI-LIMESCALE + ANTI-CHLORINE CS112
	 11" REPLACEMENT CARTRIDGE ANTI-LIMESCALE + ANTI-CHLORINE CS11
	 STACKING KIT
	 ADAPTER PLATES
	 SCALE KLEEN

RECOMMENDED BINS

RECOMMENDED								
 S500 + 1 2 SPIKA MS1000R	 S750 + 1 2 SPIKA MS1000R	 S900 + 1 2 SPIKA MS1000R	 S1050 + 1 2 SPIKA MS1000R	 SCS350 + 1 2 SPIKA MS1000R	 SCS700 + 1 2 SPIKA MS1000R	 SCD900 + 1 2 SPIKA MS1000R	 SCD1400 + 1 2 SPIKA MS1000R	 SCD1800 + 2 SPIKA MS1000R

TECHNICAL SCHEME

SPIKA MS 1000 REMOTE

RIGHT SIDE VIEW

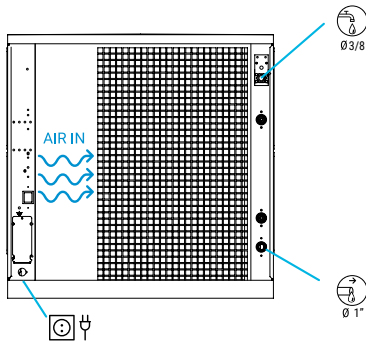

FRONTAL VIEW

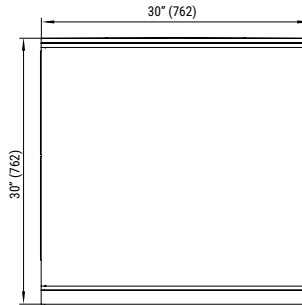

LEFT SIDE VIEW

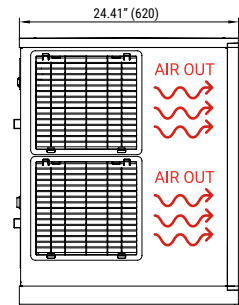

RC10

CENTRAL CROSS SECTION VIEW OF THE BASE

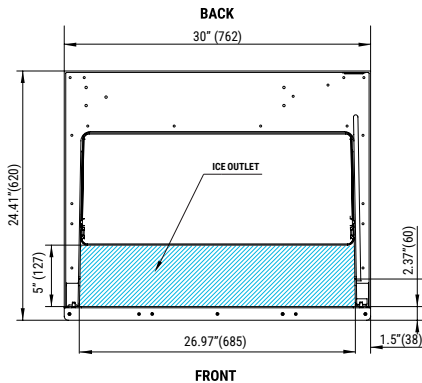

FRONTAL VIEW

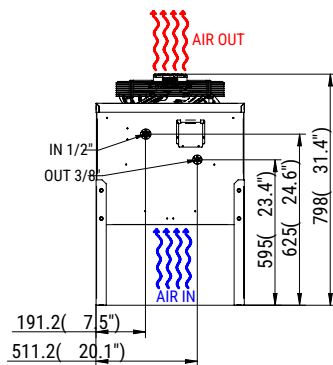

TOP VIEW

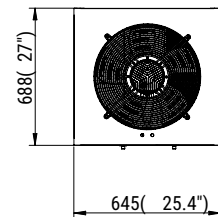

* All dimensions in inches (and mm)

OPERATING CONDITIONS

PRODUCTION (LBS) 60Hz

±10% V

41°F/109°F

41°F/95°F

14.5 psi (1 bar) / 87 psi (6 bar)

400/800 Ice cubes/cycle

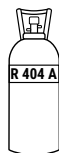

V	Hz	ph
220	60	1N



HALF DICE

SPIKA MS1000R AIR COOLED

°F	50°	60°	70°	86°
°C	10°	15°	21°	30°
50°	1076	1065	1058	1003
10°				
68°	1041	1032	1025	970
21°				
90°	1014	1010	1007	926
32°				
109°	882	860	838	728
43°				

MODELS

SPIKA MS 1000 R A

RC10

	ASHRAE CONDITIONS (BTu/h)	(W)	(W) 109°F	(AWG/mm ²)	(n.)	FUSE	100lbs 90°F / 70°F (Kwh/100 lbs)	gal 100lbs (l/h)	HEAT REJECTED (BTu/h) (W)	(lbs)	(lbs)		
SPIKA MS 1000 R A	23,892	7,002	1,912	14/2.5	3	20	4.46	1.39	26.47	13,294	3,896	214	246
RC10	-	-	206	14/1.5	3	10	-	-	-	-	-	88	110



ITV Ice Makers, Inc.
9550 Satellite Blvd, Suite 100
Orlando, FL 32837
Phone: 1 407 826 1860 | Fax: 1 407 826 1861
Toll Free: 1 888 488 1423
sales@itvice.com | www.itvice.com



SERVICE
service@itvice.com
Skype: service@itvice.com
PHONE: +1 888 488 1423
FROM 8AM TO 5PM EST

WARRANTY:
ICE MAKERS - 3 YEARS PARTS AND LABOR
EVAPORATOR - 5 YEARS PARTS AND LABOR
COMPRESSOR - 5 YEARS PARTS



VERTICAL SYSTEM